



TORQ® G2

system reactor for filter media

INSTRUCTIONS



TORQ® G2 Dock & TORQ® G2 Body 0.75 | 1.0 | 2.0

CONGRATULATIONS

Congratulations to your new Nyos® TORQ® G2 media reactor.

Please read the instructions and safety information carefully before you use the device.

CONTENTS

SAFETY INFORMATION	3
WARRANTY.....	4
INSTALLATION AND OPERATION	6
RECOMMENDED MEDIA CAPACITIES AND TANK SIZES.....	12
FAQ AND TROUBLE SHOOTING	13
GENERAL INFORMATION.....	14
MAINTENANCE AND CLEANING.....	15
SPARE PARTS AND EXPLODED DRAWINGS	16

SAFETY INFORMATION

- Only connect the unit if the electrical data of the unit and the power supply coincide. The unit data is to be found on the unit type plate.
- The pump may only be connected to an outlet with earth contact.
- The pump must be supplied through a residual current device (RCD) with a rated residual current of no more than 30 mA. Ask your electrician.
- Unplug all devices submerged in the water prior to any contact with aquarium water.
- This device is only approved for inside use and only for aquarium purposes.
- The power cord of this device cannot be replaced. If damaged, the device must be scrapped. Do not bend the power cord and do not carry device on power cord.
- The device may not run dry. It may only be used for liquids between the temperatures of +4°C to +35°C (39°F to 95°F). The pump motor is protected from overheating.

- This device is not intended for the use by persons (including children) with limited physical, sensory or mental capacities, unless they are supervised by a person responsible for the safety or this person instructed them on how to use the device. Children must be supervised to ensure they do not play with the device.



The device may not be disposed of in the standard household rubbish. It must be professionally disposed.

WARRANTY

The consumer receives for this product a 12-month warranty for material defects and assembly errors from the date of purchase.

For being granted the warranty, the device must be submitted completely and together with the sales slip. Any shipments to us must be postage paid. If the warranty claim is justified, the defective part is at our discretion either repaired or replaced.

EXCLUSION OF WARRANTY

This warranty does not cover:

- Soiling and lime scale deposits
- Dry running of the pump
- Wear and tear damages on wear and tear parts (e.g. rotor, seals)
- Improper handling and use (including the use of products from other manufacturers)
- Any kind of damages (e.g. wires of electrical devices)
- Technical changes and modifications to any of the components
- Faulty installation
- Consequential damages from improper use, lack of maintenance or non-compliance with safety regulations

INSTALLATION AND OPERATION

STEP 01 Positioning the Nyos® TORQ® G2 Dock in your sump

- You receive your Nyos® TORQ® G2 Dock as plug-and-play model. The pump has already been installed.
- Nyos® TORQ® G2 has been designed for in sump use. The unit cannot be used outside the sump.
- Put Nyos® TORQ® G2 Dock in your sump. Please ensure that the bottom of the sump is even. This helps ensure that the water can run off evenly. A constant water level in the sump is not required.
- The unit must not be in contact with the side panes of the sump (Fig. 1).
- Only plug in the device when body has been placed on the dock (see Step 03).

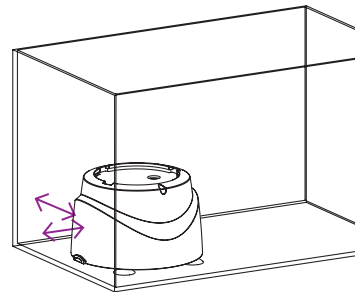

(Fig. 1)

STEP 02 Filling the TORQ® G2 Bodies

General information on filling Nyos® TORQ® G2 Bodies

- The lower insert and the lid can be removed from the tube with a slight turn (Fig. 2a and 2b).
- Make sure both marks are aligned when connecting tube and insert (Fig. 3).
- The filter sponge for the lid has a hole in the center (emergency overflow). If water exits through the hole, the sponge needs to be cleaned.
- The 0.8mm grid is recommended for small grain filter media. The 1.5mm grid is recommended for larger grain filter media like activated carbon. The use of an additional filter sponge is not necessary.
- Please refer to the filling quantities in the table on page 12.
- Only Body 2.0: The separating grid with the acrylic stick in the middle has a slightly higher diameter than the lower grid. It needs to be bent a little bit when inserted and removed.

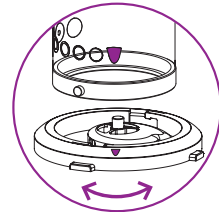

(Fig. 2a)

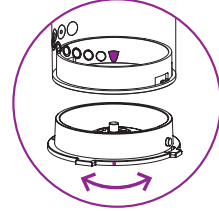

(Fig. 2a)

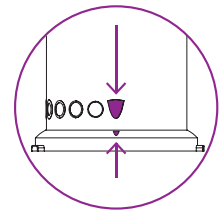

(Fig. 3)

Filling with one filter media

1. Remove the lid by slightly turning it.
2. The separating grid included with Body 1.0 and 2.0 (part no. 5, page 17) can be removed when only one filter media is used.
3. Add the filter media from the top. Put the lid back on and turn it to lock position (Fig. 4).

Filling with two filter media (TORQ® G2 Body 1.0 and Body 2.0 only)

Hint: The media in the upper chamber can be changed easier. We therefore recommend to place the media with the shorter run time in the upper chamber.

1. Turn the body upside down and remove the grid insert.
2. Keep hold of the acrylic stick, and insert the first filter media.



(Fig. 4)

- Put the insert on the acrylic stick and close the tube by turning the insert.
- Turn the body again and remove the lid. Add the second filter media and put the lid back on (Fig. 5).

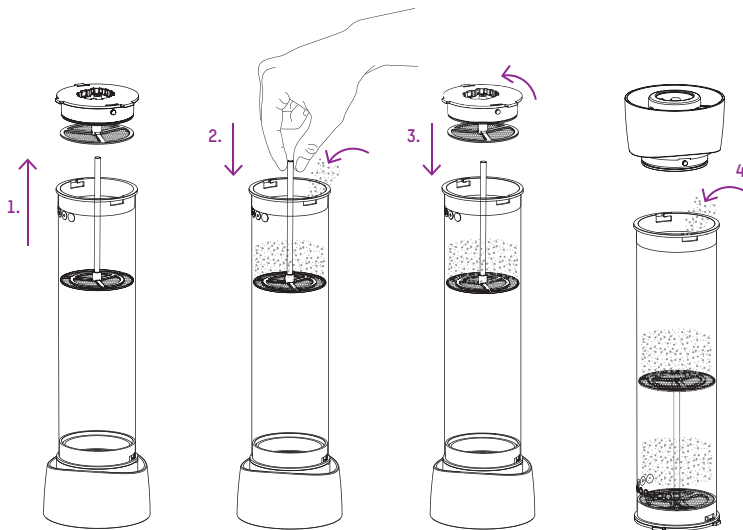

(Fig. 5)

STEP 03 Insert TORQ® G2 Body and start operation

- Place the filled body on the dock. The body can only be placed on the dock if the two violet markings point to each other. This is the position for removal and insertion. In this position, the flow rate is zero.
- Plug in the pump. By turning the body counter-clockwise, you can increase the flow rate. The flow rate can be read from the scale at the bottom end of the body.
- The filter media (exception: zeolite) should be hold in suspension at all times. If the filter media collects at the top sponge, the flow rate is too high. If you cannot detect any motion in the filter media, the flow rate is too low.

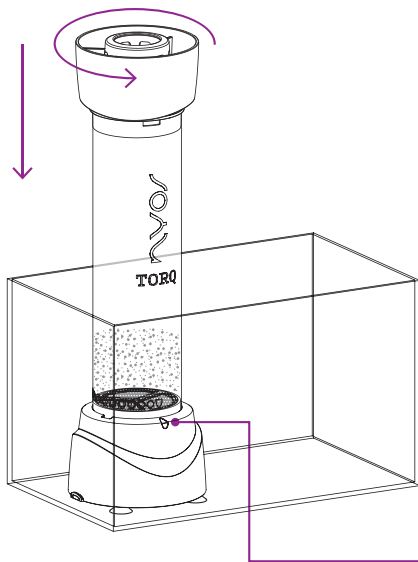

- The Nyos® TORQ® G2 media reactor was designed in such a way that it is virtually bubble-free and silent at optimum use. This requires a run-in period of several days. A smear layer is created on the outside of the body, so that the water fully moistens the body.

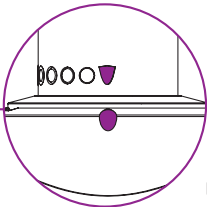

(Fig. 6)

Removal position



(Fig. 7)

Setting the flow rate

RECOMMENDED MEDIA CAPACITIES AND TANK SIZES

	TORQ® G2 Body 0.75	TORQ® G2 Body 1.0	TORQ® G2 Body 2.0
Usage of one filter media			
Phosphate remover (Nyos® PHOSI-EX)			
Maxium capacity	450 ml (15 fl oz)	750 ml (25 fl oz)	1.500 ml (50 fl oz)
Optimal capacity	350 ml (12 fl oz)	500 ml (17 fl oz)	1.000 ml (34 fl oz)
Tank size up to	675 l (180 gal)	1.125 l (300 gal)	2.250 l (600 gal)
Activated Carbon (Nyos® ACTIVE CARB)			
Maxium capacity	650 ml (22 fl oz)	900 ml (30 fl oz)	1.800 ml (60 fl oz)
Optimal capacity	450 ml (15 fl oz)	650 ml (22 fl oz)	1.300 ml (44 fl oz)
Tank size up to	650 l (170 gal)	900 l (240 gal)	1.800 l (475 gal)
Zeolite (Nyos® ZEO)			
Maxium capacity	750 ml (25 fl oz)	1.000 ml (34 fl oz)	2.000 ml (68 fl oz)
Tank size up to	300 l (80 gal)	400 l (100 gal)	800 l (200 gal)
Usage of two filter media			
Phosphate remover (Nyos® PHOSI-EX)			
Maxium capacity	–	375 ml (12.5 fl oz)	750 ml (25 fl oz)
Optimal capacity	–	250 ml (8.5 fl oz)	500 ml (17 fl oz)
Tank size up to	–	550 l (145 gal)	1.125 l (300 gal)
Activated Carbon (Nyos® ACTIVE CARB)			
Maxium capacity	–	450 ml (15 fl oz)	900 ml (30 fl oz)
Optimal capacity	–	300 ml (10 fl oz)	650 ml (22 fl oz)
Tank size up to	–	450 l (120 gal)	900 l (240 gal)
Zeolite (Nyos® ZEO)			
Maxium capacity	–	500 ml (17 fl oz)	1.000 ml (34 fl oz)
Tank size up to	–	200 l (50 gal)	400 l (100 gal)

FAQ AND TROUBLE SHOOTING

PROBLEM	CAUSE	SOLUTION
Bubbles in the outlet and splattering	Water does not fully moisten the outside of the body	Wait for a few days (even after cleaning) to allow the smear layer on the outside of the body to regenerate itself
	Flow rate is too high	Reduce flow rate
	TORQ® G2 is on uneven surface	Place TORQ® G2 on an even surface
Filter sponge clogs fast	Too much detritus in sump	Clean sump; use filter socks
Filter media is not being properly floated	Filter sponge or grid clogged	Clean sponge or grid
	Flow rate is too low	Increase flow rate
	Pump is clogged	Clean the pump
	Use of too much filter media	Reduce amount of filter media (see table on page 12)
Filter media collects at the top filter sponge and clogs it	Flow rate is too high	Reduce flow rate
	Too much filter media is used	Reduce amount of filter media (see table on page 12)
Filter media goes into sump	Filter media is too fine	Use a larger filter media If necessary add filter floss to the lid (Fig. 6)
	Flow rate is too high	Reduce flow rate
	Use of too much filter media	Reduce the amount of filter media (see table on page 12)
Lid can only be placed on acrylic tube with difficulty	Clamp effect too strong	Rub the silicone rings with Vaseline, silicone grease or similar

GENERAL INFORMATION

Emergency overflow

The filter sponge of the lid of Nyos® TORQ® G2 has a hole in the middle (emergency overflow). In case water exits the hole, clean the sponge.

Using filter floss

For very dirty or abrasive filter media, you can use filter floss in the free space of the lid (Fig. 8). Generally speaking, however, this is not necessary.

Reduction in pump performance

At the time of delivery, the pump is set to a maximum performance of 1.000 l/h (264 gph). Should you use very little filter media in the long term, you can regulate your pump downwards manually in order to achieve finer nuances in the setting. To do this, please take the pump out of the dock and turn the slider on the suction side of the pump. Usually, however, this will not be necessary.

MAINTENANCE AND CLEANING

- Nyos® TORQ® G2 Bodies can be cleaned easily with tap water. There is no need to use detergents.
- The grid of the pump should be cleaned regularly in order to ensure constant performance. To do this, please remove the pump from the dock. The grid of the pump can be removed easily.
- When changing filter media, please clean filter sponge and grid.

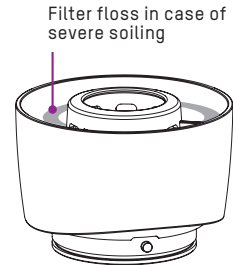

[Fig. 8]

PARTS LIST TORQ® G2 BODIES

Number	TORQ® G2 Body 0.75	TORQ® G2 Body 1.0	TORQ® G2 Body 2.0
1	Lid 70 Art.: T-BSP_4331	Lid 70 Art.: T-BSP_4331	Lid 100 Art.: T-BSP_4348
2	Filter sponge for lid 70 Art.: T-BSP_2535	Filter sponge for lid 70 Art.: T-BSP_2535	Filter sponge for lid 100 Art.: T-BSP_2542
3	O-Ring for lid 70 Art.: T-BSP_2559	O-Ring for lid 70 Art.: T-BSP_2559	O-Ring for lid 100 Art.: T-BSP_2566
4	Tube 750 ml Art.: T-BSP_4355	Tube 1.000 ml Art.: T-BSP_4362	Tube 2.000 ml Art.: T-BSP_4379
5		Separating grid with acrylic stick 70 (0.8 mm) Art.: T-BSP_4386	Separating grid with acrylic stick 100 (0.8 mm) Art.: T-BSP_4393
6	Grid 70 (0.8 mm) Art.: T-BSP_4409	Grid 70 (0.8 mm) Art.: T-BSP_4409	Grid 100 (0.8 mm) Art.: T-BSP_4416
7	Grid 70 (1.5 mm) Art.: T-BSP_4454	Grid 70 (1.5 mm) Art.: T-BSP_4454	Grid 100 (1.5 mm) Art.: T-BSP_4461
8	Insert 70 Art.: T-BSP_4423	Insert 70 Art.: T-BSP_4423	Insert 100 Art.: T-BSP_4430

EXPLODED DRAWINGS TORQ® G2 BODIES

TORQ® G2 Body 0.75 TORQ® G2 Body 1.0 TORQ® G2 Body 2.0

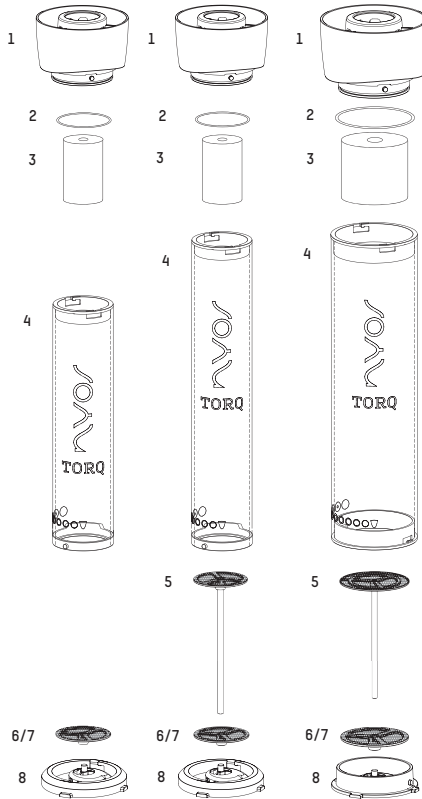

PARTS LIST AND EXPLODED DRAWING TORQ® G2 DOCK

Number	TORQ® G2 Dock
11	Motor block Part No.: T-DSP_Motor
12	Impeller Part No.: T-DSP_Imp
13	Shaft Part No.: T-DSP_2740
14	Bearing Part No.: T-DSP_2757
15	Pump housing with slider Part No.: T-DSP_2764
16	Dock housing Part No.: T-DSP_2771
17	Dock base plate Part No.: T-DSP_2788
18	Sucion Cups 4x Part No.: T-DSP_4447

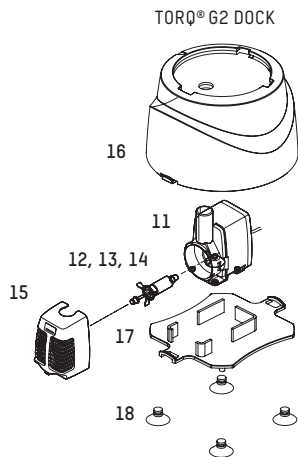

NOTES

Manufactured by
Nynos® Aquatics GmbH
Siemensstr. 26
70825 Korntal-Muenchingen, Germany
www.nynos.info, support@nynos.info

Patents pending in EU, US and elsewhere. TORQ® is a protected
trademark of Nynos® Aquatics GmbH.



www.facebook.com/nynos.aquatics

